

2.5 m<sup>3</sup>/h - 0.07 - 0.2%  
11 GPM - 1:1500 - 1:500  
0.3 - 6 bar  
4.3 - 85 psi

**DI1500**

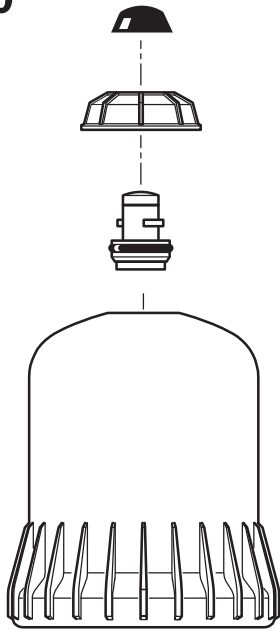

MPDI112

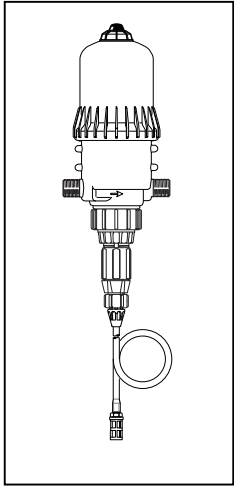
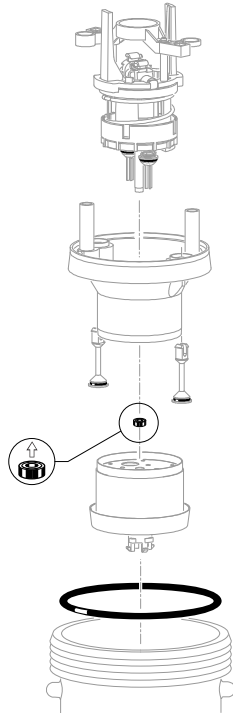

EMD1003

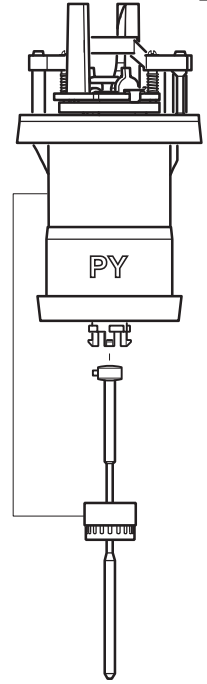

PCDI012

MPDI115

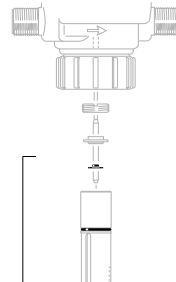
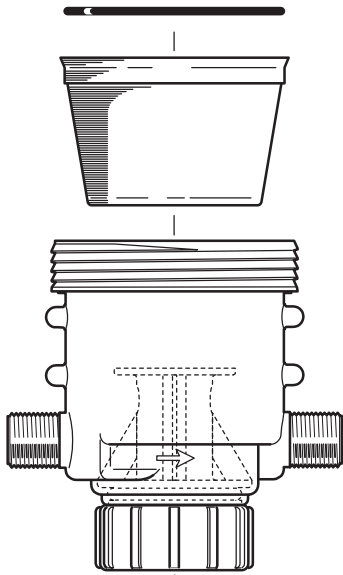

PJD1069

CDDI048

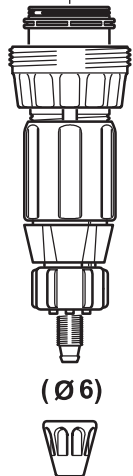

(Ø 6)

MPDI005

