

2.5 m<sup>3</sup>/h - 1 - 5%  
11 GPM - 1:100 - 1:20  
0.3 - 6 bar  
4.3 - 85 psi

**DI150**

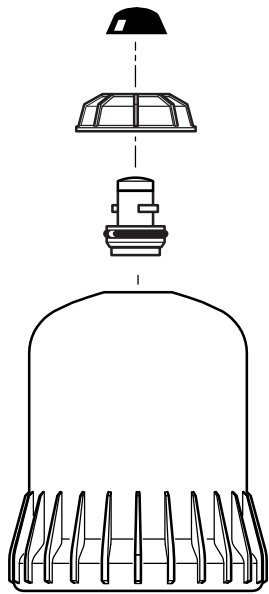

**MPDI112**

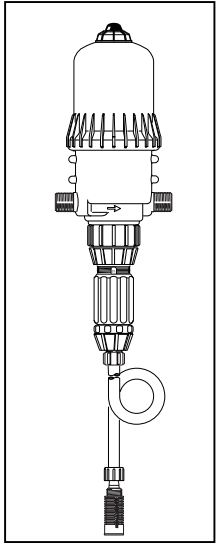
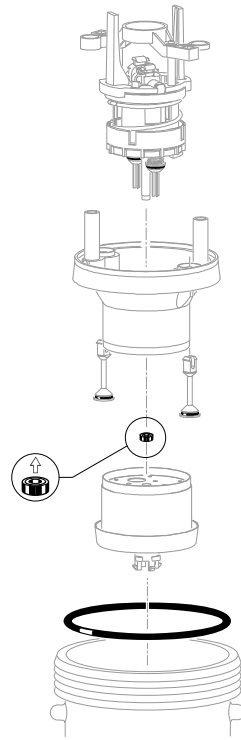

**EMDI003**

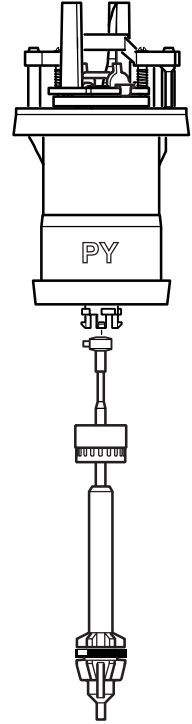

**PCDI015**

**MPDI115**

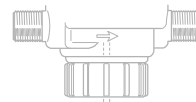
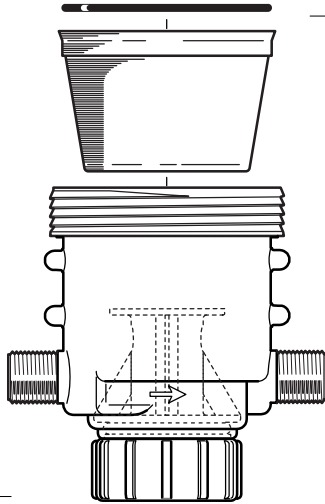

**PJD1060**

**CDDI052 (Ø 12)**

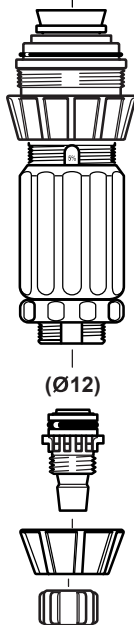

(Ø12)

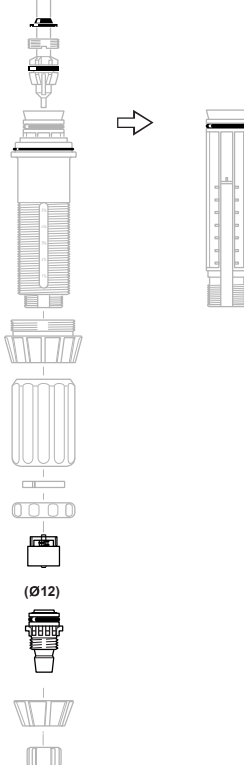

**MP222**