

D8RE2

8 m³/h - 0.2 - 2%
40 GPM - 1:500 - 1:50
0.15 - 8 bar
2.2 - 116 psi

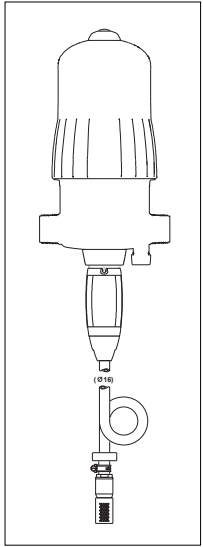

8MP039

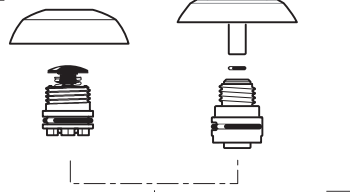

MPDI196

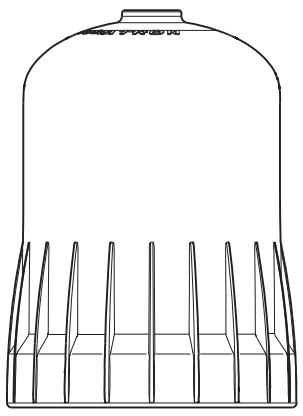

8PJ067

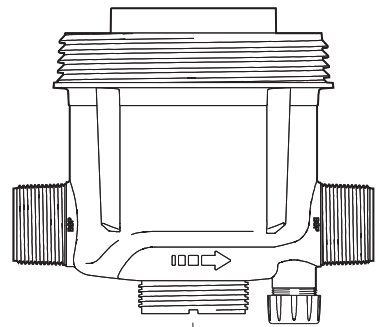

8CD033

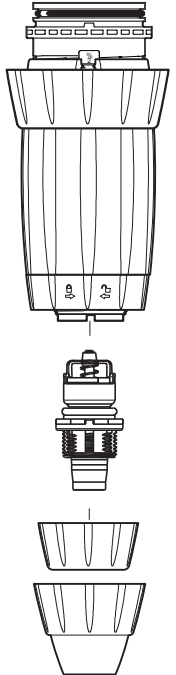

PJDI120V

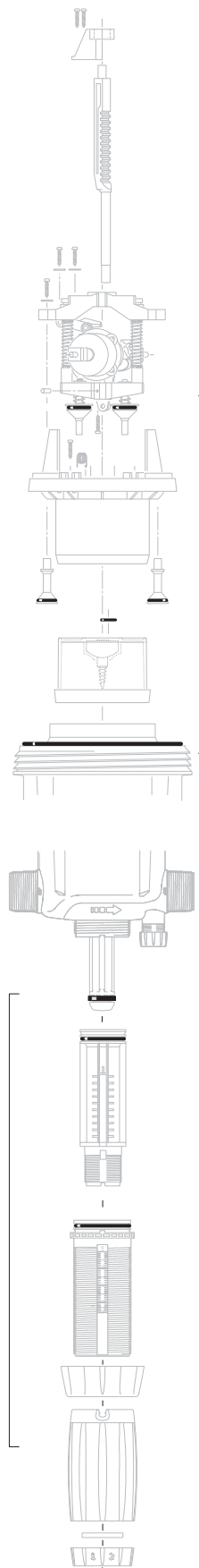

8EM003

8PC002

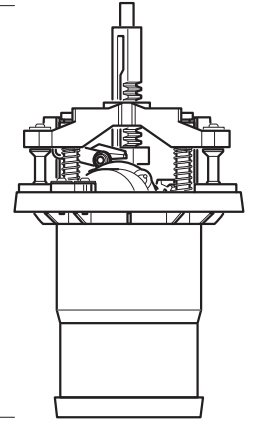

8PP011



PJDI119

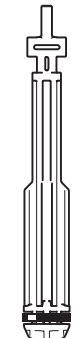

(Ø16)

MPDI189

